





TRIVELLE
WORM AUGERS
TARIÈRES
ERDBOHRER
HOYADORAS
ШНЕКОВЫЕ БУРЫ

6

 Trivelle
 Worm augers
 Tarières

 Erdbohrer
 Hoyadoras
 Шнековые буры специального исполнения

> RT130
 > R15-A

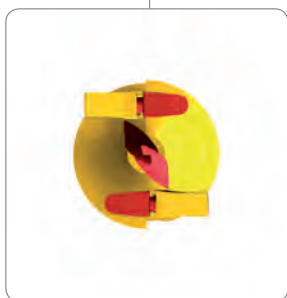
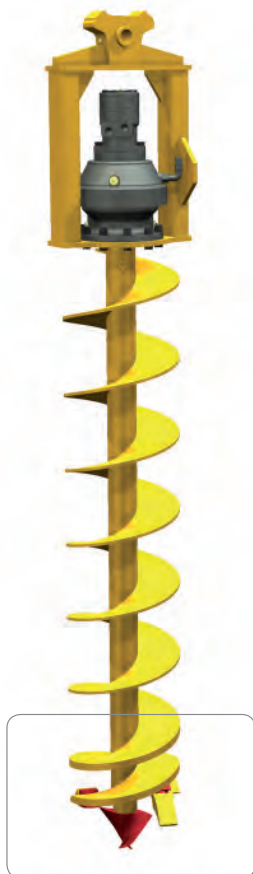

> RT170
 > R16
 > RA

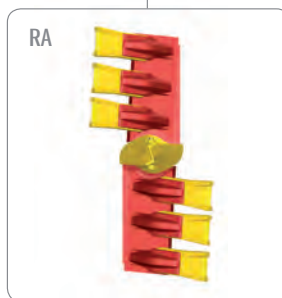

> RT750
 > R16
 > RB

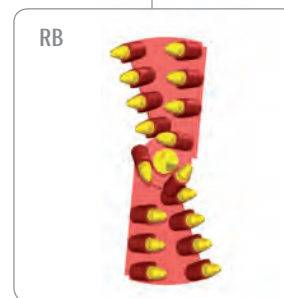
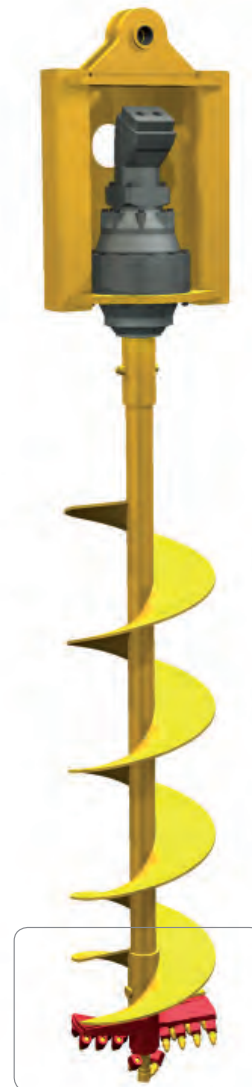

Motoriduttore - Motoreducer - Motoréducteur - Motoruntersetzungsgetriebe

Modello	Peso	Motore	Riduzione	Pressione massima	Coppia	Velocità rotazione	Portata olio massima	Dimensioni	
Model	Weight	Motor	Reduction	Max. pressure	Torque	Rotation speed	Max. oil flow	Sizes	
Modèle	Poids	Moteur	Réduction	Pression maxi	Couple	Vitesse de rotation	Débit d'huile maxi	Dimensions	
Modell	Gewicht	Motor	Reduktion	Max. Druck	Drehmoment	Drehgeschwindigkeit	Max. Ölleistung	Abmessungen	
	kg	cm ³		bar	daNm	giri/lit	lit/min	C	D
RT130	65	130	1 : 6	200	200	1,3	50	400	600
RT170	120	170	1 : 6	240	330	1	60	460	770
RT750	265	75	1 : 45	350	1885	0,3	160	630	960

 Trivelle
 Worm augers
 Tarières

 Erdbohrer
 Hoyadoras
 Шнековые буры специального исполнения

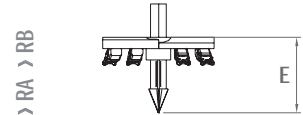
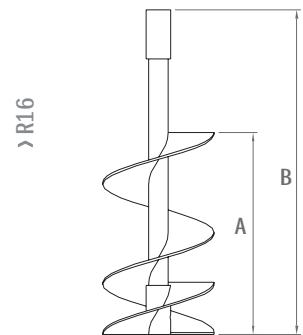
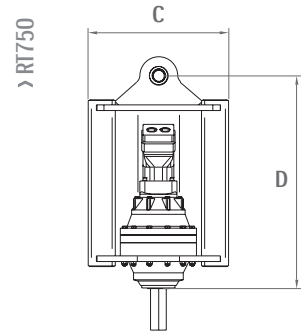
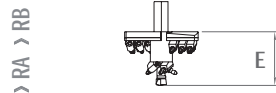
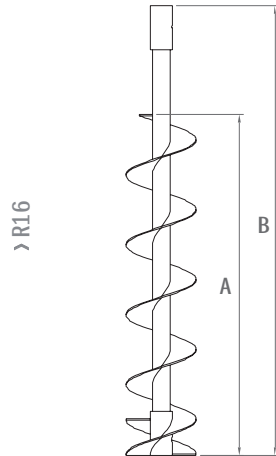
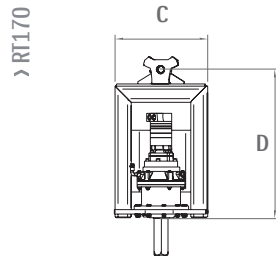
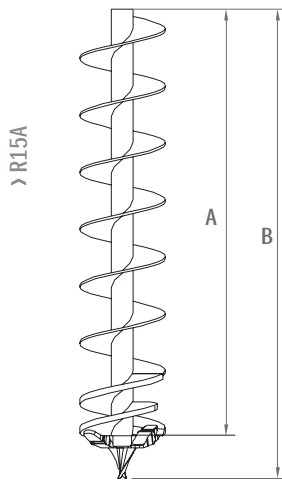
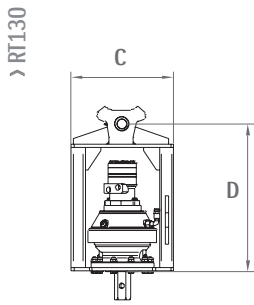

Coclea - Auger worm - Mèche - Schnecke

Modello	Diametro	Dimensioni		Peso
Model	Diameter	Sizes		Weight
Modèle	Diamètre	Dimensions		Poids
Modell	Durchmesser	Abmessungen		Gewicht
	mm	A	B	kg
R15A	200	1500	1650	50
	250	1500	1650	60
	300	1500	1650	75
	350	1500	1650	95
	400	1500	1650	105
R16	200	1000	1550	40
		1800	2350	55
	250	1000	1550	45
		1800	2350	60
	300	1000	1550	55
		1800	2350	85
	350	1000	1550	60
		1800	2350	90
	400	1000	1550	70
		1800	2350	110
	500	1000	1550	85
		1800	2350	130
600	1000	1550	100	
	1800	2350	160	
750	1000	1550	120	
	1800	2350	195	

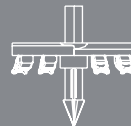

RA › punta per terreni normali
 › auger tip for normal grounds
 › tête pour terrains normaux
 › Bohrer für normalen Boden

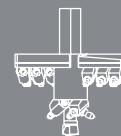

RB › punta per terreni duri
 › auger tip for hard grounds
 › tête pour terrains durs
 › Bohrer für harte Boden

Punta - Auger tip - Tête - Bohrer

Modello	Diametro	Dimensioni	Peso
Model	Diameter	Sizes	Weight
Modèle	Diamètre	Dimensions	Poids
Modell	Durchmesser	Abmessungen	Gewicht
	mm	E	kg
RA RB	200	250	23
	250	250	24
	300	250	26
	350	290	33
	400	330	35
	500	330	43
	600	350	47
	750	380	50